

SIZE:

UDG-37

1085

UDG-32

960

UDG-27

830

UDG-22

705

Blade of gate is long enough to contact, and extend past, opposite side guardrail post by 30mm or more from center line of support block position.

MIN. 30

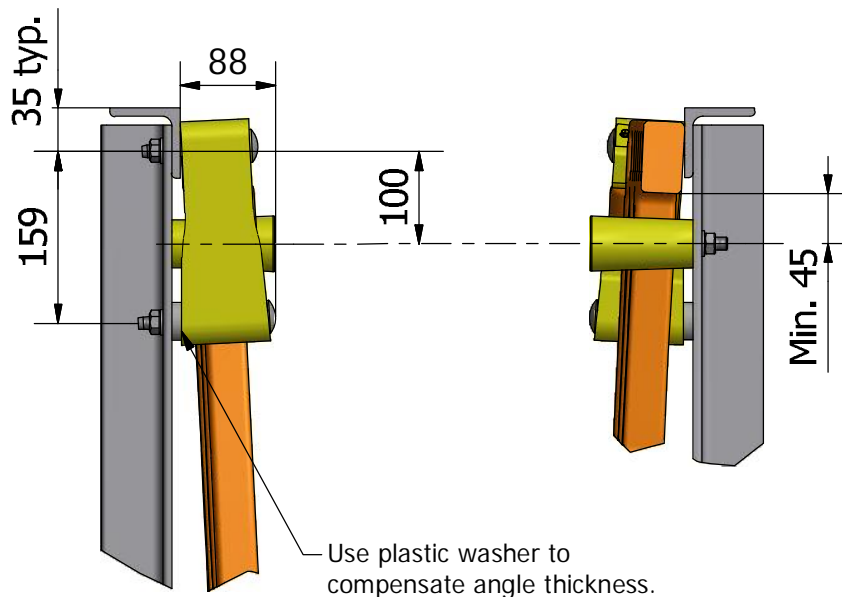
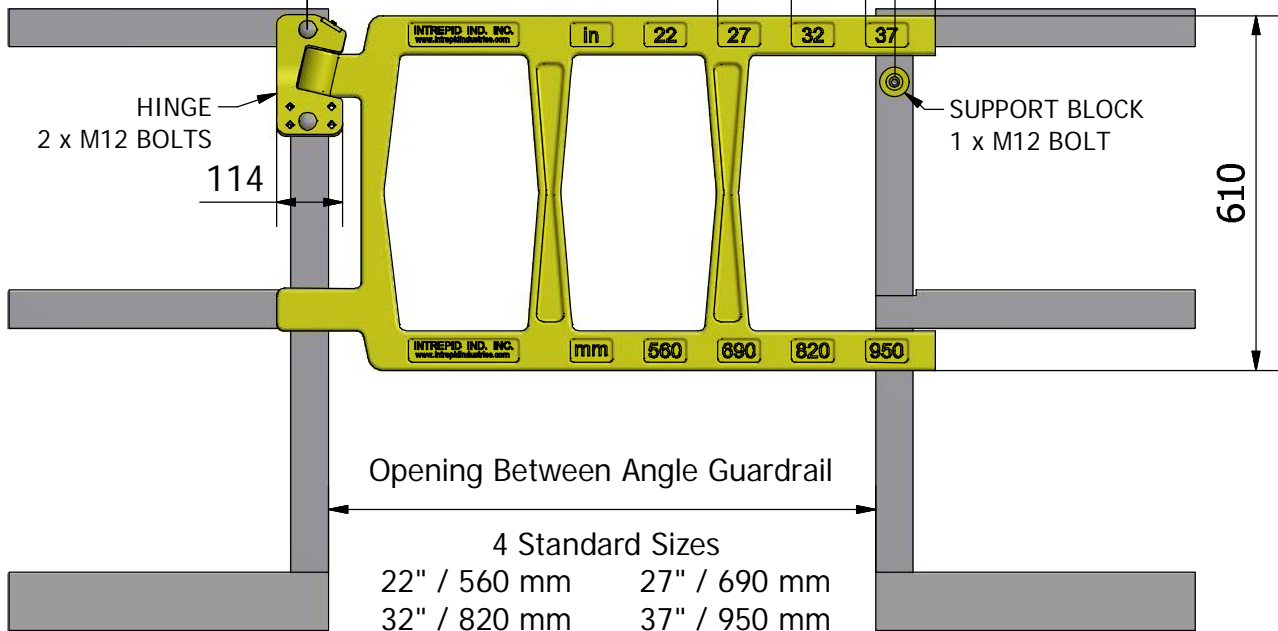

Support block is mounted below the top rail of gate to prevent vertical deflection. IT SHOULD NOT MAKE CONTACT WITH THE GATE OR INTERFERE WITH IT SWINGING CLOSED. Field installations: simply mount the block at least 45mm BELOW the closed bar.